

Android LCD Advertising Display User manual



WA9



WA8

Precautions

Thank you for purchasing and using this product. When unpacking please check the accessories inside the box are completed. Before connecting the unit and turning on the power, please read the operation instructions carefully and keep the operation instructions for future use.

Safety Guide

IMPORTANT NOTES! High-pressure danger!

Do not open the case to avoid electric shock. Maintenance should be commissioned by professionals. Improper handling may cause electric shock or fire. To ensure your safety and the service life of the product, please read the following safety precautions carefully before use.

- ◇ Before using the unit, you must read and understand all instructions.
 - ◇ The user's manual must be kept for future use.
 - ◇ The warning instructions on the machine's operation instructions must be strictly observed. Operation must be in accordance with all instructions.
 - ◇ Do not use accessories not recommended by the manufacturer. Improper use of the settings may lead to unexpected malfunctions.
 - ◇ Please use power adapter compliant with the color LCD monitor, the AC power cord connected to the power outlet, please check the TV specifications of the voltage source requirements are suitable for local power supply conditions, if you are not sure the type of power supply, and Dealer or the local electricity department.
 - ◇ Do not use any object to press or winding the power cord. Damaged power cords can cause electric shock or fire.
 - ◇ Do not attempt to repair the machine, because the machine has high-pressure devices and other damage devices, will cause harm to the human body or the TV itself, be sure to let professional maintenance personnel for maintenance.
 - ◇ Do not touch the control parts which are not mentioned in the instruction manual. Improper adjustment of the control parts not mentioned in the operating instructions can damage the unit and increase the maintenance work of the professional technician.
 - ◇ When replacing the unit, check with the service personnel that the accessories specified by the manufacturer or the same as the original are used. Improper use of accessories can result in fire, electric shock, and damage to the TV.
 - ◇ To ceiling mount the unit on roof, please follow up the installation instruction recommended by manufacturer.
 - ◇ Before cleaning the unit, unplug the power. Clean the unit with a slightly damp cloth. Do not use liquid cleaners or spray cleaners when cleaning.
 - Unplug the AC power cord when not using the unit for long time.
- Do not place the unit on an unstable cart, stand, tripod or table.
- ◇ Please ensure that the air around the machine, the machine is not covered or blocked vents.
 - ◇ The LCD panel of this machine is made of sensitive material, do not touch any LCD monitor with any item. If the unit falls from height or is impacted, the LCD panel may be broken. Stop using the unit immediately.
- Do not place the unit direct sunlight or near heat sources, such as radiators, heating equipment, stoves and other heat objects. Each switching time interval not less than 3 seconds.

Contents

1、 MACHINE INTRODUCTION.....	1
1.1 Machine Specifications:.....	1
1.2 Picture.....	2
1.2.1 Wall-mount type:.....	2
1.2.2 Interface diagram:.....	2
1.2.3 Installation diagram:.....	3
1.2.4 Floor standing type:.....	3
1.2.5 Interface diagram.....	4
1.2.6 Machine installation diagram machine.....	5
1.3 Remote control and button description:.....	6
2、 SOFTWARE INSTALLATION AND NETWORK CONNECTION.....	8
2.1 Computer-side installation management software.....	8
2.2 There are two ways to connect a device to network.....	8
3、 TERMINAL OPERATION INSTRUCTIONS.....	9
3.1 Exit the player mode.....	9
3.2 Set up network connection.....	9
3.3 Adjust the machine display range.....	10
3.4 Enter the player mode.....	10
4、 SOFTWARE OPERATION.....	11
4.1 System login.....	11
4.2 Exit system.....	12
5、 COMMON TROUBLES AND HANDLING METHODS OF NETWORK ADVERTISING PLAYER.....	13
6、 AFTER-SALES SERVICE AND CONTACT:.....	14

1、 Machine introduction

1.1 Machine Specifications:

Main Hardware Specifications	
Video format	Support WMV、 AVI、 FLV、 RM、 RMVB、 MPEG 、 TS、 MP4
Picture format	Support BMP、 JPEG、 PNG
USB2.0 interface	USB HOST*2、 USB socket*2
Ethernet	1, 10M / 100M adaptive Ethernet
SD card	Compatible SD (maximum support 32GB)

Other standard interfaces and functions:

Storage interface	SD card	data storage, maximum support 32G
	USB*2	HOST interface, support data storage, data import, USB mouse and keyboard, camera, touch screen, etc.
Ethernet	RJ45 interface	supports 100M wired network
HDMI interface	Standard interface	supports HDMI data output, maximum support 1080P
Mic interface	Standard Interface	3.5mm interface
3G interface	PCI-E	supports Huawei, ZTE and other PCI-E 3G module

1.2 Picture

1.2.1 Wall-mount type:



WA8

1.2.2 Interface diagram:

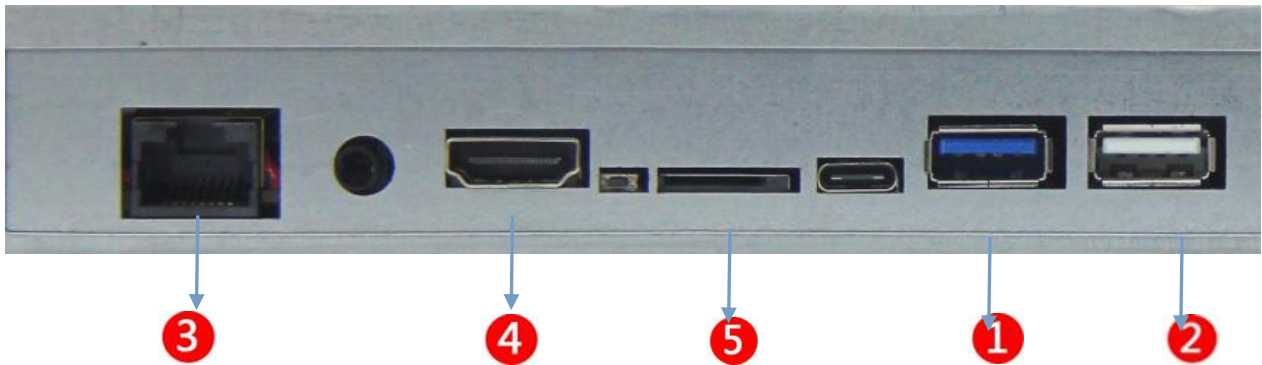

1 2 USB 2.0 interface: USB interface is compatible with the use of USB2.0 or USB1.1 standard USB devices.

3 Wired network jack: This network jack supports RJ-45 cable.

4 HDMI: HDMI output.

5 SD card slot: support SD high-speed memory card device.

1.2.3 Installation diagram:

Installation instructions

Wall - mounted advertising machine installation details

Our products are easy to install and do not need professional installers

Advertising machine installation details

Our product installation is very simple, do not need a professional installer, as long as the following tools, according to the steps easily.



<Drill, hammer, screwdriver, level, marker, wrench>

Installation instructions

Note: LCD advertising machine for fragile products, do not touch the screen surface of hard objects, in the advertising machine not hanging wall, please put the advertising machine on the foam.

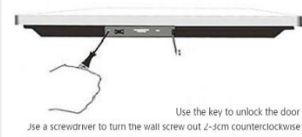

Use the key to unlock the door
Use a screwdriver to turn the wall screw out 2-cm counterclockwise ①



Face the advertising machine to the desktop by hand to the wall plate in the direction of the door lock to remove the hanging board ②

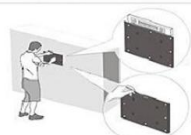

Attach the wall panel horizontally to the wall and mark where fixing screws are needed ③



Drill out 6-8 holes with a 6-8mm drill, with a locating hole of 50mm depth ④

Solid load bearing wall with perforation	
Bit size	Drill hole depth
3/8" inc	3.00" inch
8 mm	70 mm

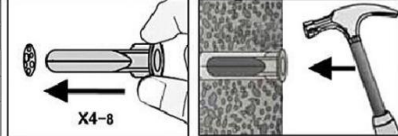

X4-8

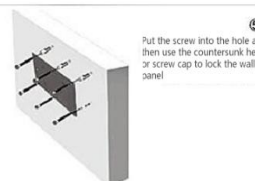

Put the screw into the hole and then use the countersunk head or screw cap to lock the wall panel ⑤

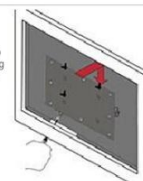

Advertising machine behind the hanging hole from the top down to hang the wall hanging board. Check in the lock door can be ⑥

1.2.4 Floor standing type:



1.2.5 Interface diagram

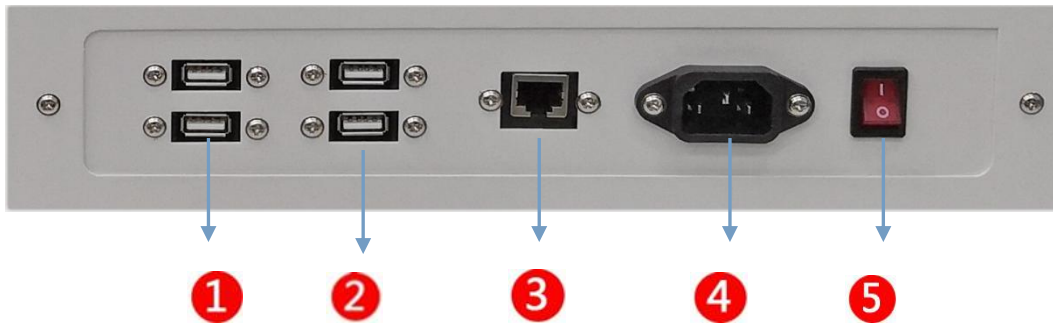

1 2 USB 2.0 interface: USB interface is compatible with the use of USB2.0 or USB1.1 standard USB devices.

3 Wired network jack: This network jack supports RJ-45 cable.

4 Power supply slot: support 100-240V power.

5 Power switch: press this button directly to turn on/off the machine.

1.2.6 Machine installation diagram machine

Installation instructions

Floor AD machine installation details

Our product installation is very simple, do not need a professional installation personnel, to have a complimentary hexagon wrench, according to the steps easily



The fuselage bottom



Base with positive



Base on the back



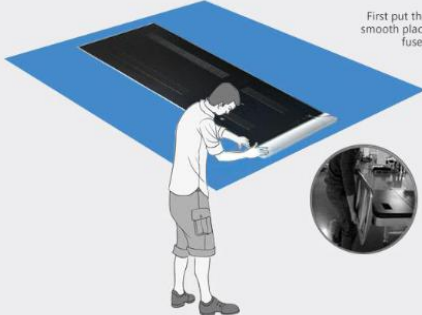

The first step

First put the fuselage flat in a smooth place, the base into the fuselage exactly



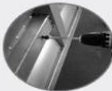

The second step

Screw up, screw into each hole, and make sure to tighten













The third step



















Side up the fuselage and you're done



1.3 Remote control and button description:



	Power Button, control switch, Short press stand-by, long press pop-up menu shutdown or restart
	Mute Button to control the sound switch
	Stop Button
	Play / Pause Button
	During playback, press this key to enter the next song
	During playback, press this key to enter the previous song
	Set Button, quickly open the settings interface
	Copy Button
	Volume Reduction
	Turn it up

	Move The cursor up
	Confirm Button
	Move the cursor to the left
	Move The cursor to the right
	Move The cursor down
	Menu Button
	Return button
	Home Button, quick jump to the home page
	Flying Mouse Button, pop-up mouse arrows, with up and down about button can be moved
	The number one button
	The number two button
	The number three button
	The number four button
	The number five button
	The number six button
	The number seven button
	The number eight button
	The number nine button
	Symbols. Push Button
	The number zero button
	Delete Button

2、 Software installation and network connection

2.1 Computer-side installation management software

- a, Please take out the CD in the accessory box of the machine before use.
- b, Prepare a PC, and then install the operation software in CD disk. please follow up the software operation instructions.
- c, Double click the operation software to finish installation.

2.2 There are two ways to connect a device to network

Method 1: Connect the RJ45 network cable to the RJ45 network interface of the advertising display device and the other end to the network interface of the switch.

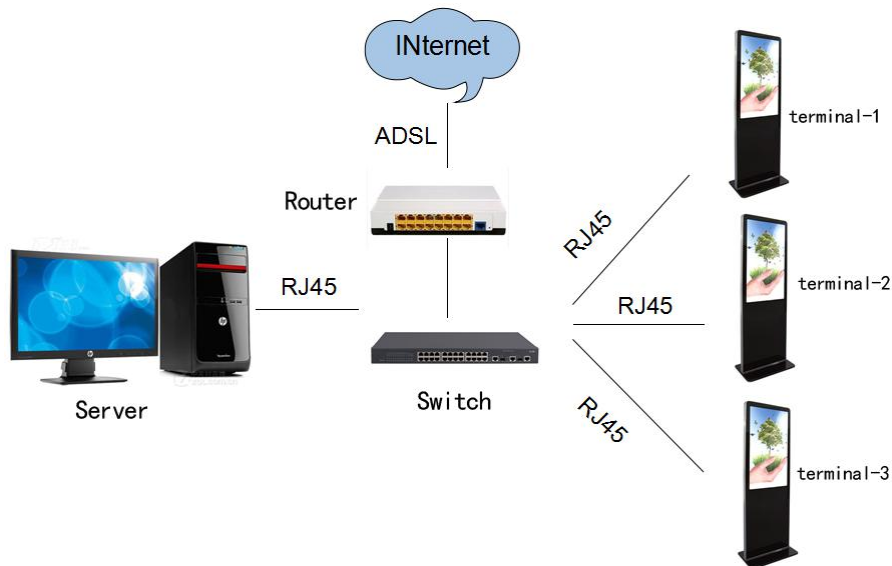

Method 2: through the wireless router connected with the advertising terminal.

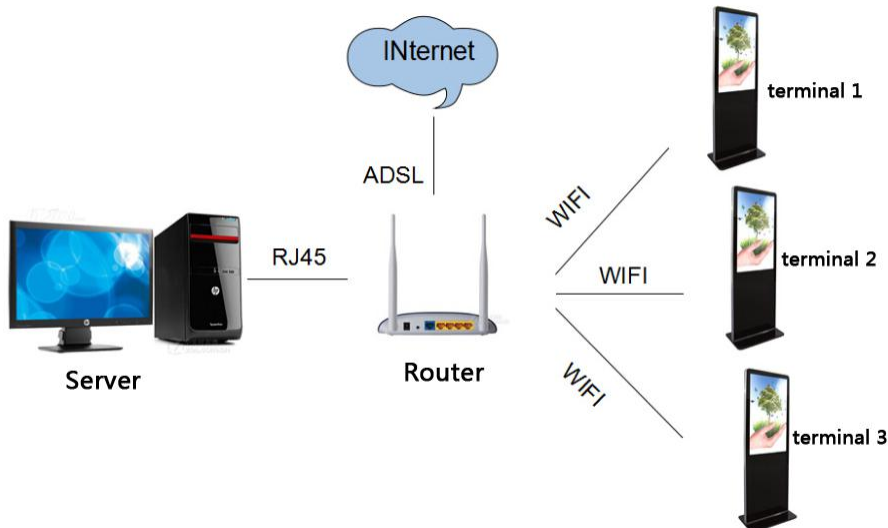

3、 Terminal operation instructions

3.1 Exit the player mode

When the power is turned on, the machine will automatically turn on and enter the player mode as shown in below figure. Connect the USB mouse and click the "wheel" in the middle of the mouse, pop-up setting and exit menu on screen bottom menu. Click the exit button to exit the player mode.

3.2 Set up network connection

There are 3 ways to set up network connection (Wired is recommended)

Mode 1: wired connection,

Plug one end of the RJ45 cable into the player's wired network jack and the other end into the network switch's network jack. The machine automatically recognizes the network and obtains the corresponding IP address.

Mode 2: wifi connection

Click the "Settings" button at the bottom of the system page - "System Settings -" wifi, click to open the wifi switch, on the right side come out wifi wireless network link point. Click the desired connected network and input password, then wireless network is connected.

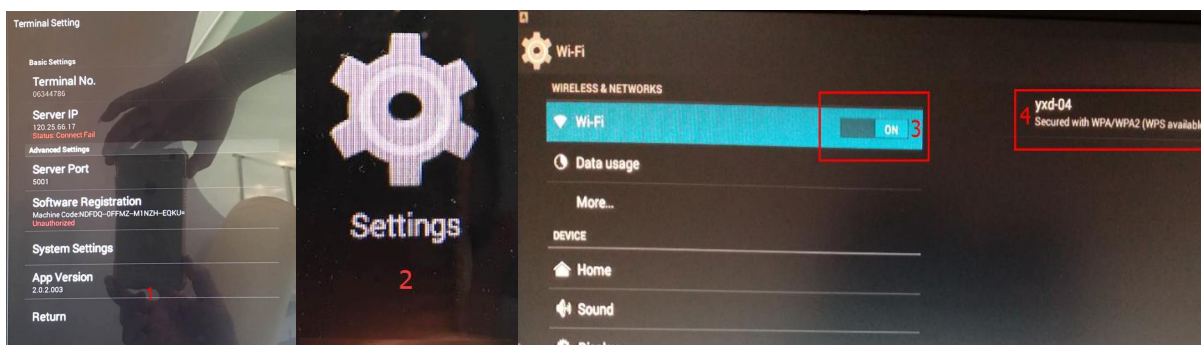

Mode 3: 3G / 4G network connection

Click the "Apply" button on the lower left corner of the system home page to enter the application interface, click "Settings" - "More -" Internal 3G - "Use the internal 3G / 4G, click ✓ behind 3G / 4G ,then 3G/ 4G network is on connection status.

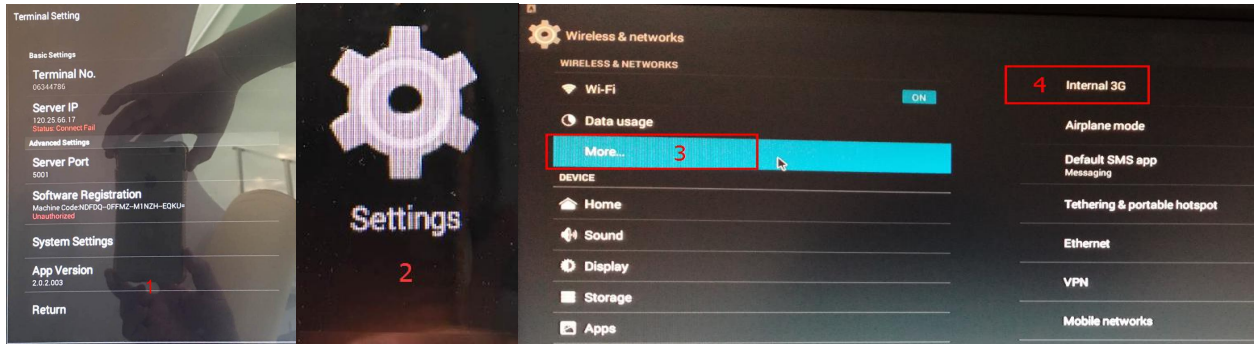

Note: The machine must be turn off or power off before insert 3G / 4G network card , and then reboot the machine to ensure 3G / 4G Internet network function is normal.

3.3 Adjust the machine display range

Click the Apply button on the lower left corner of the system's home page to enter the application interface. Click the "Settings" - "Display -" cut screen edges, and adjust the displayed area by dragging the scroll bar in the pop-up menu.

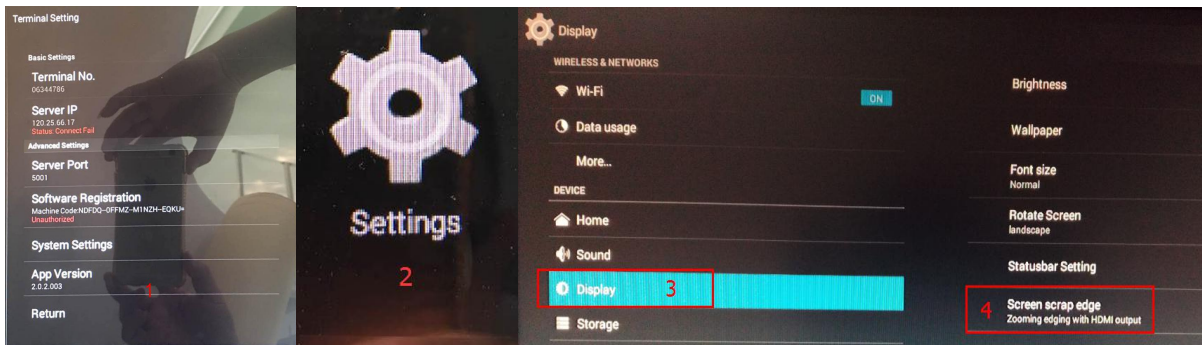

3. 4 Enter the player mode

Click on the system home page on the lower left corner of the application button, enter the application interface, click the XdsClient player icon to enter the player mode, it takes 10 seconds to enter the player mode .

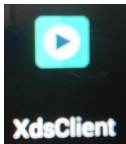

3.5,Set the server address and player name

In the player mode, click the “wheel” in middle of mouse pop-up settings interface, click "server", pop-up settings dialog box, input the server IP address or domain name , click OK.

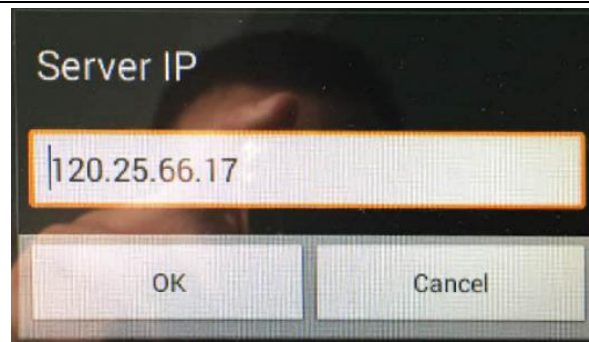

4、 Software Operation

4.1 System login

Please read software operation user manual for detailed software operation and program edit.

After finishing installation, double-click the icon on the desktop [XDS Management], start the management side, enter the user name and password, click Settings to modify the server address, as shown below settings.





- The initial user name and password are admin.
- The default server IP is 127.0.0.1. Which should be modified to the actual IP address, the port is 5001.

☆ When the management side and the server is not installed on the same computer, the server IP column fill in the current server's IP address. When the server is deployed in the WAN here to fill in the WAN IP address, when the server is deployed in the LAN, then fill in the LAN IP address.

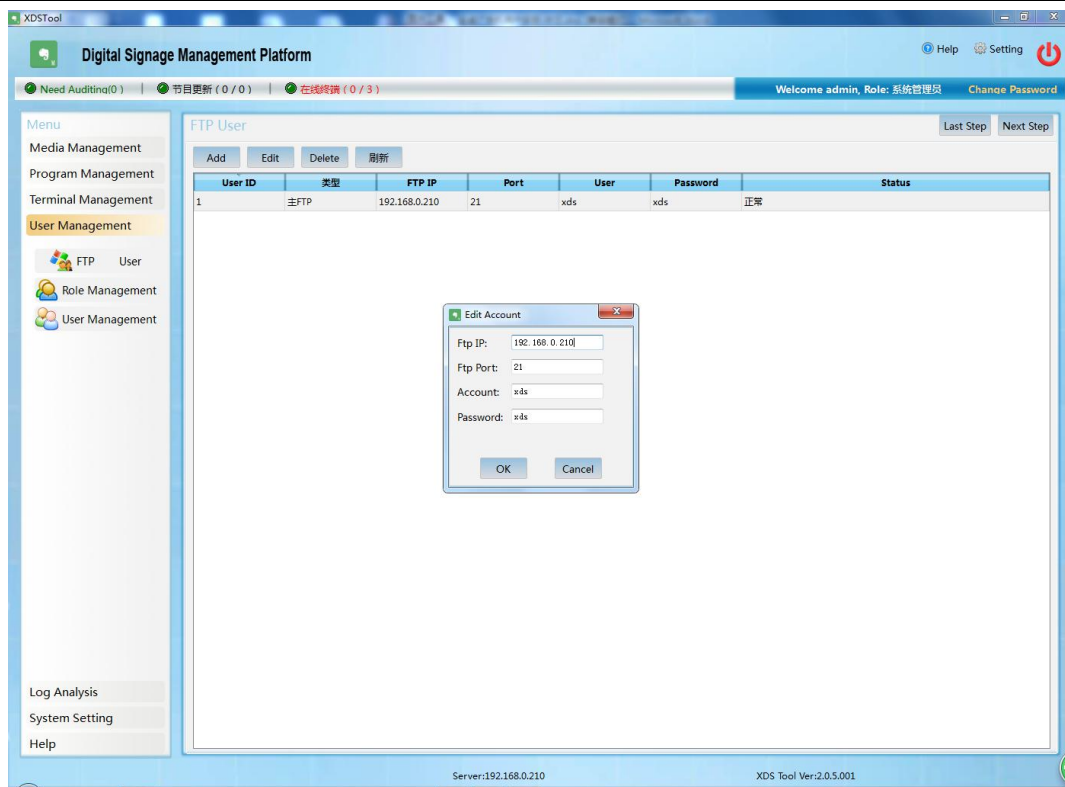
Click **【Login】** to enter the main management interface, as shown below.



4.2 Exit system

Click the close button in the upper right corner , click "confirm" to exit the system, or click the close button of the dialog to exit the system. As shown below .

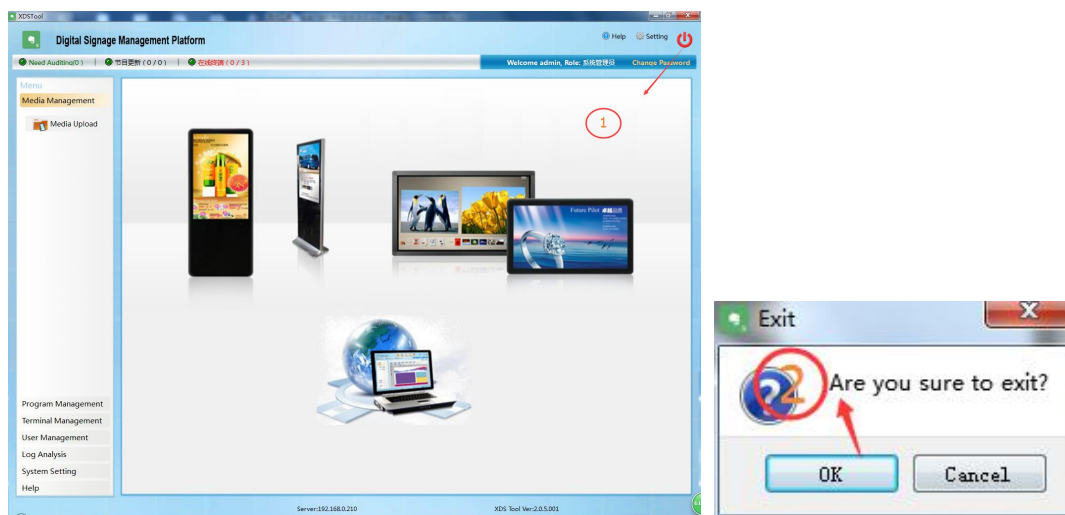

5、 Common Troubles and Handling Methods of Network Advertising Player

num	Failure phenomenon	Troubleshooting
1	The terminal is offline	<ol style="list-style-type: none"> 1. Check whether the terminal network is properly connected. 2. Check that the server IP address settings is correct 3. Check if the firewall of the server computer's is turned off 4. “Ping” the terminal IP in server, whether it is normal. 5. Check whether the terminal port number is 5101 6. Network is normal, but can not always see the terminal, then restart the switcher and router between terminal and server. <p>If problem remain the same after above troubleshooting,you need to check if the client network management TCP and UPD protocol is open. (you can also check the network environment, the server is arranged in the first layer switch or the core switch)</p>
2	The server connection is unsuccessful	<ol style="list-style-type: none"> 1. Check if the server's XDSServer service is started; 2. Check if IP, port number, user name and password under the management setting is correct. 3. Check the server network under the management end to is normal, you can use Ping command test; 4. Check the firewall of the server opens port 5001,21 and 80 ;
3	The program does not play.	First "restore the default settings" and then "clear the material" and then re-send the program.
4	can send programs In the server, fail to send if change a computer.	Check the time between the computer and the server is same.
5	Bulk send program says "operation failed"	Delect the installation directory, reinstall the server, database, most important is to increase the bandwidth.
6	Use USB disk to import the edited program, screen becomes black	The server is the latest version, import edit the program leads to terminal blank screen. Reload server, edit program and use USB disk to import Program .

6、 After-sales service and contact:

If your products have any problems, please contact ours sales or directly call the below after-sales service telephone:

Customer Service Hotline: +86 755 27865713

Company email: info@asianda.cn

Web: <https://www.asianda.cn/>

Product Range Pictures:

